

CGHV35150

150 W, 2900 - 3500 MHz, 50V, GaN HEMT for S-Band Radar Systems

Cree's CGHV35150 is a gallium nitride (GaN) high electron mobility transistor (HEMT) designed specifically with high efficiency, high gain and wide bandwidth capabilities, which makes the CGHV35150 ideal for 2.9 - 3.5 GHz S-Band radar amplifier applications. The transistor is supplied in a ceramic/metal flange and pill package.

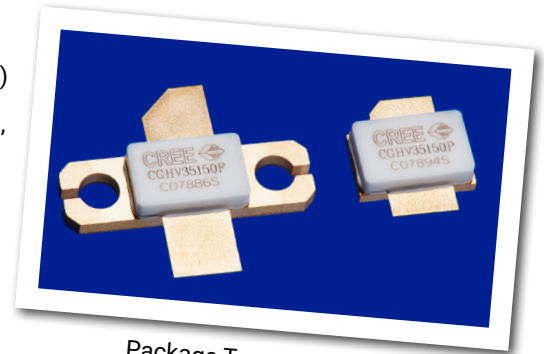

Package Type: 440193 / 440206
PN: CGHV35150F / CGHV35150P

Typical Performance 3.1 - 3.5 GHz ($T_c = 85^\circ\text{C}$)

Parameter	3.1 GHz	3.2 GHz	3.3 GHz	3.4 GHz	3.5 GHz	Units
Output Power	180	180	180	170	150	dB
Gain	13.5	13.5	13.5	13.3	12.7	dBc
Drain Efficiency	50	49	50	49	48	%

Note: Measured in the CGHV35150-AMP application circuit, under 300 μs pulse width, 20% duty cycle, $P_{IN} = 39 \text{ dBm}$

Features:



- Rated Power = 150 W @ $T_{CASE} = 85^\circ\text{C}$
- Operating Frequency = 2.9 - 3.5 GHz
- Transient 100 μsec - 300 μsec @ 20% Duty Cycle
- 13.5 dB Power Gain @ $T_{CASE} = 85^\circ\text{C}$
- 50 % Typical Drain Efficiency @ $T_{CASE} = 85^\circ\text{C}$
- Input Matched
- <0.3 dB Pulsed Amplitude Droop

Large Signal Models Available for ADS and MWO

Absolute Maximum Ratings (not simultaneous)

Parameter	Symbol	Rating	Units	Conditions
Pulse Width	PW	300	μs	
Duty Cycle	DC	20	%	
Drain-Source Voltage	V _{DSS}	125	Volts	25°C
Gate-to-Source Voltage	V _{GS}	-10, +2	Volts	25°C
Storage Temperature	T _{STG}	-65, +150	°C	
Operating Junction Temperature	T _J	225	°C	
Maximum Forward Gate Current	I _{GMAX}	30	mA	25°C
Maximum Drain Current ¹	I _{DMAX}	12	A	25°C
Soldering Temperature ²	T _S	245	°C	
Screw Torque	τ	40	in-oz	
Pulsed Thermal Resistance, Junction to Case ³	R _{θJC}	0.81	°C/W	300 μsec, 20%, 85°C
Pulsed Thermal Resistance, Junction to Case ⁴	R _{θJC}	0.86	°C/W	300 μsec, 20%, 85°C
Case Operating Temperature	T _C	-40, +150	°C	30 seconds

Note:

¹ Current limit for long term, reliable operation

² Refer to the Application Note on soldering at <http://www.cree.com/rf/document-library>

³ Measured for the CGHV35150P at P_{DISS} = 150 W

⁴ Measured for the CGHV35150F at P_{DISS} = 150 W

Electrical Characteristics

Characteristics	Symbol	Min.	Typ.	Max.	Units	Conditions
DC Characteristics¹ (T_C = 25°C)						
Gate Threshold Voltage	V _{GS(th)}	-3.8	-3.0	-2.3	V _{DC}	V _{DS} = 10 V, I _D = 28.8 mA
Gate Quiescent Voltage	V _{GS(Q)}	-	-2.7	-	V _{DC}	V _{DS} = 50 V, I _D = 500 mA
Saturated Drain Current ²	I _{DS}	21.6	25.9	-	A	V _{DS} = 6.0 V, V _{GS} = 2.0 V
Drain-Source Breakdown Voltage	V _{BR}	150	-	-	V _{DC}	V _{GS} = -8 V, I _D = 28.8 mA
RF Characteristics³ (T_C = 85°C, F₀ = 3.1 - 3.5 GHz unless otherwise noted)						
Output Power at 3.1 GHz	P _{OUT}	130	170	-	W	V _{DD} = 50 V, I _{DQ} = 500 mA, P _{IN} = 39 dBm
Output Power at 3.5 GHz	P _{OUT}	100	135	-	W	V _{DD} = 50 V, I _{DQ} = 500 mA, P _{IN} = 39 dBm
Gain at 3.1 GHz	G _p	12.0	13.3	-	dB	V _{DD} = 50 V, I _{DQ} = 500 mA, P _{IN} = 39 dBm
Gain at 3.5 GHz	G _p	11.0	12.3	-	dB	V _{DD} = 50 V, I _{DQ} = 500 mA, P _{IN} = 39 dBm
Drain Efficiency at 3.1 GHz	D _E	40	47	-	%	V _{DD} = 50 V, I _{DQ} = 500 mA, P _{IN} = 39 dBm
Drain Efficiency at 3.5 GHz	D _E	40	44	-	%	V _{DD} = 50 V, I _{DQ} = 500 mA, P _{IN} = 39 dBm
Amplitude Droop	D	-	-0.3	-	dB	V _{DD} = 50 V, I _{DQ} = 500 mA, P _{IN} = 39 dBm
Output Mismatch Stress	VSWR	-	-	5 : 1	Ψ	No damage at all phase angles, V _{DD} = 50 V, I _{DQ} = 500 mA, P _{IN} = 39 dBm Pulsed

Notes:

¹ Measured on wafer prior to packaging.

² Scaled from PCM data.

³ Measured in CGHV35150-AMP. Pulse Width = 300 μs, Duty Cycle = 20%.

Typical Performance

Figure 1. - CGHV35150 Typical Sparameters
 $V_{DD} = 50\text{ V}$, $I_{DQ} = 500\text{ mA}$, $T_{CASE} = 25^\circ\text{C}$

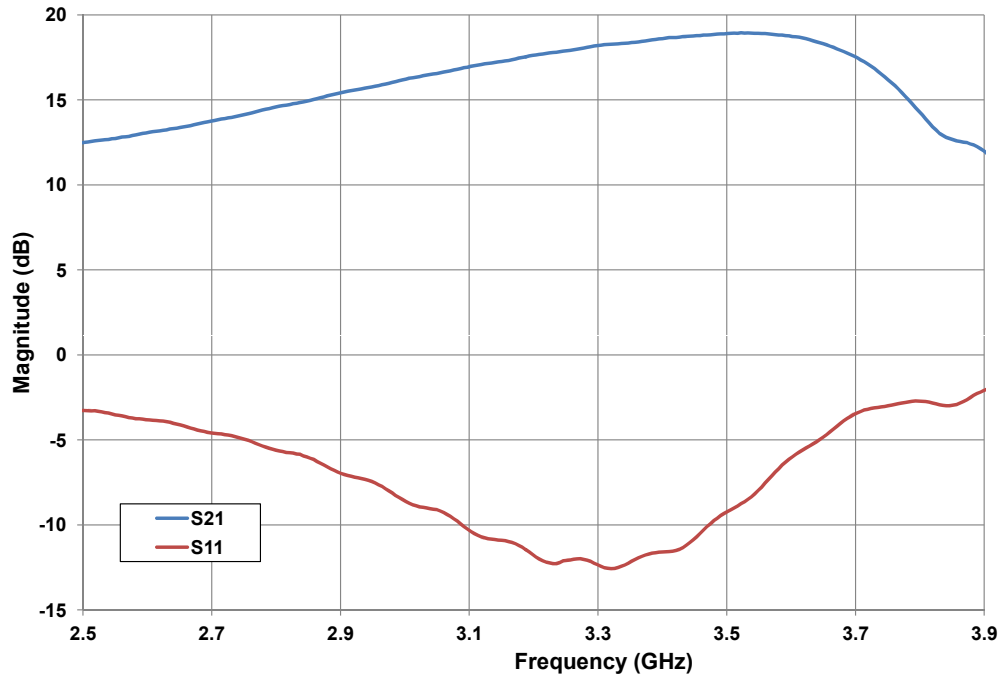
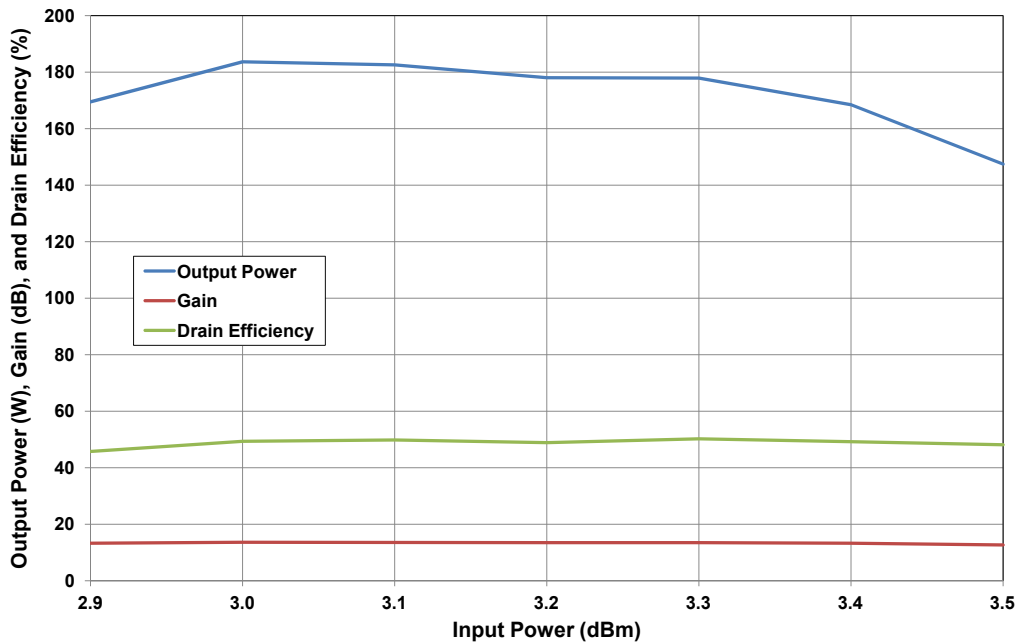

Figure 2. - CGHV35150 Typical RF Results
 $V_{DD} = 50\text{ V}$, $I_{DQ} = 500\text{ mA}$, $P_{IN} = 39\text{ dBm}$
 $T_{plate} = 85^\circ\text{C}$, Pulse Width = 300 μs , Duty Cycle = 20 %



Typical Performance

Figure 3. - CGHV35150 Output Power vs Input Power
 $V_{DD} = 50\text{ V}$, $I_{DQ} = 500\text{ mA}$, $T_{PLATE} = 85^\circ\text{C}$, Pulse Width = $300\ \mu\text{s}$, Duty Cycle = 20%

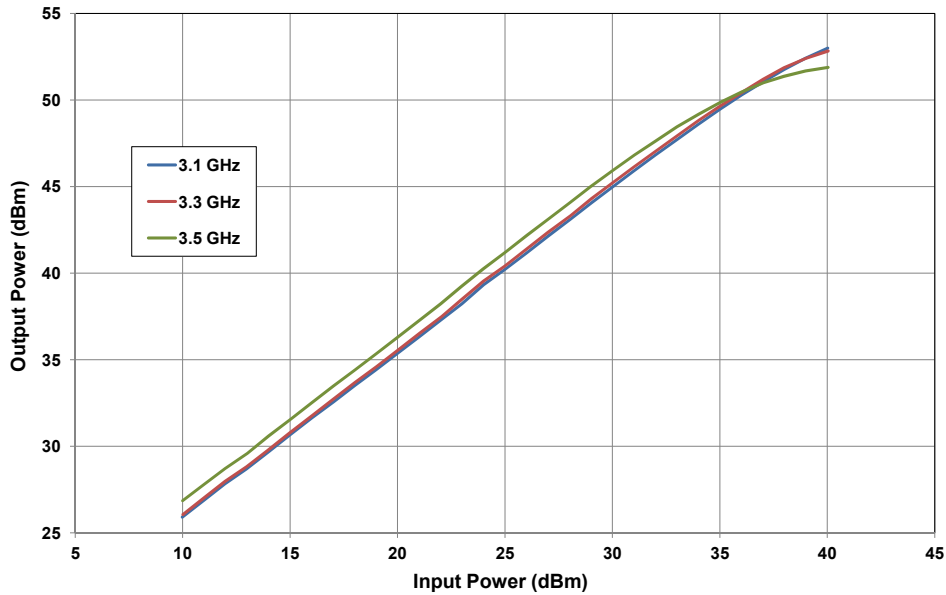
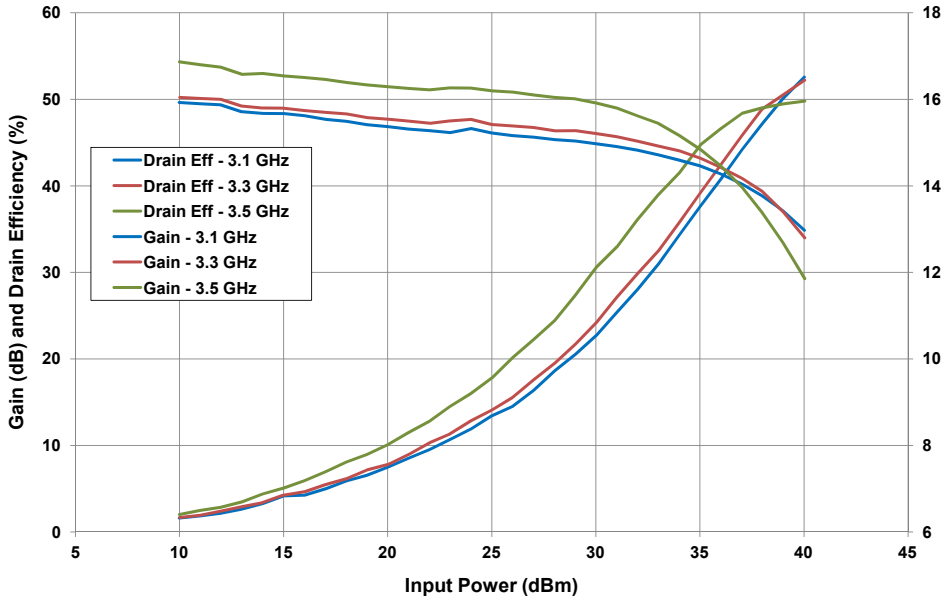

Figure 4. - CGHV35150 Gain and Drain Efficiency vs Input Power
 $V_{DD} = 50\text{ V}$, $I_{DQ} = 500\text{ mA}$, $T_{plate} = 85^\circ\text{C}$, Pulse Width = $300\ \mu\text{s}$, Duty Cycle = 20%



Electrostatic Discharge (ESD) Classifications

Parameter	Symbol	Class	Test Methodology
Human Body Model	HBM	1A (> 250 V)	JEDEC JESD22 A114-D
Charge Device Model	CDM	II (200 < 500 V)	JEDEC JESD22 C101-C

CGHV35150 Power Dissipation De-rating Curve

Figure 5. - CGHV35150 Transient Power Dissipation De-Rating Curve

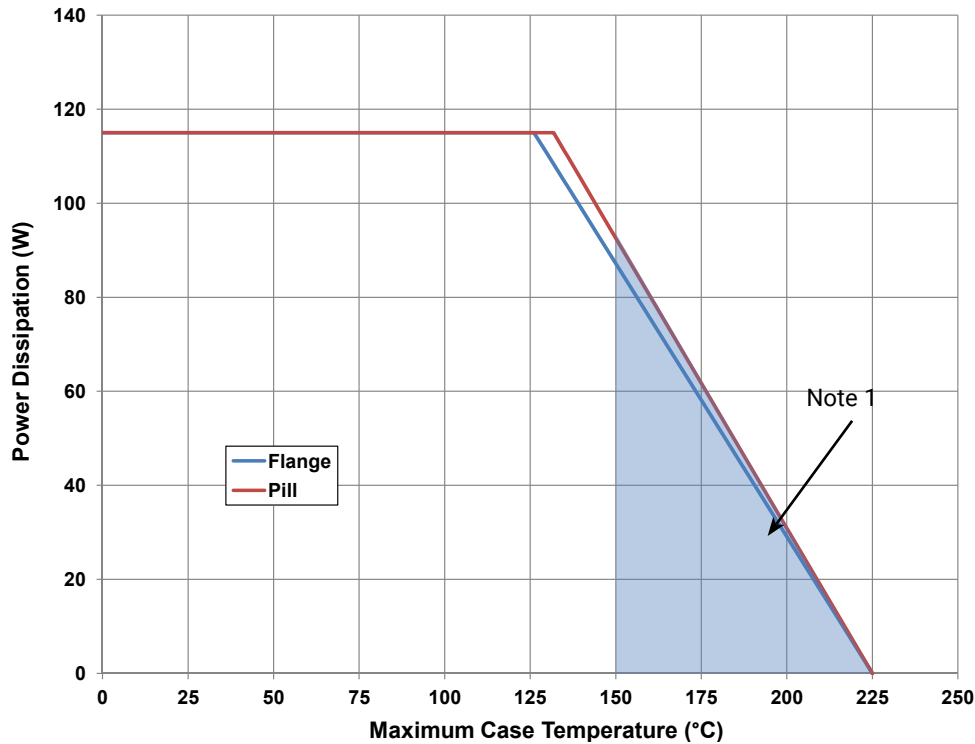

Note 1. Area exceeds Maximum Case Temperature (See Page 2).

CGHV35150-AMP Application Circuit Bill of Materials

Designator	Description	Qty
R1	RES, 511 OHM, +/- 1%, 1/16W, 0603	1
R2	RES, 5.1 OHM, +/- 1%, 1/16W, 0603	1
C1,C7,C8	CAP, 10pF, +/- 1%, 250V, 0805	3
C2	CAP, 6.8pF, +/- 0.25 pF, 250V, 0603	1
C3	CAP, 10.0pF, +/-5%, 250V, 0603	1
C4,C9	CAP, 470PF, 5%, 100V, 0603, X	2
C5,C10	CAP, 33000PF, 0805, 100V, X7R	1
C6	CAP 10uF 16V TANTALUM	1
C11	CAP, 1.0UF, 100V, 10%, X7R, 1210	1
C12	CAP, 33 UF, 20%, G CASE	1
C13	CAP, 3300 UF, +/-20%, 100V, ELECTROLYTIC	1
J1,J2	CONN, SMA, PANEL MOUNT JACK, FL	2
J3	HEADER RT>PLZ .1CEN LK 9POS	1
J4	CONNECTOR ; SMB, Straight, JACK,SMD	1
W1	CABLE ,18 AWG, 4.2	1
	PCB, RO4350, 20 MIL THK, CGHV35150	1
Q1	CGHV35150	1

CGHV35150-AMP Application Circuit Outline

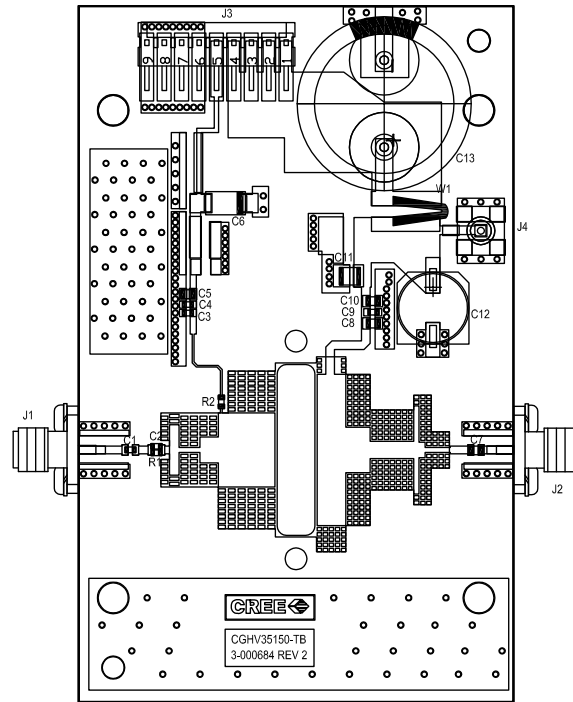

CGHV35150-AMP Application Circuit Schematic

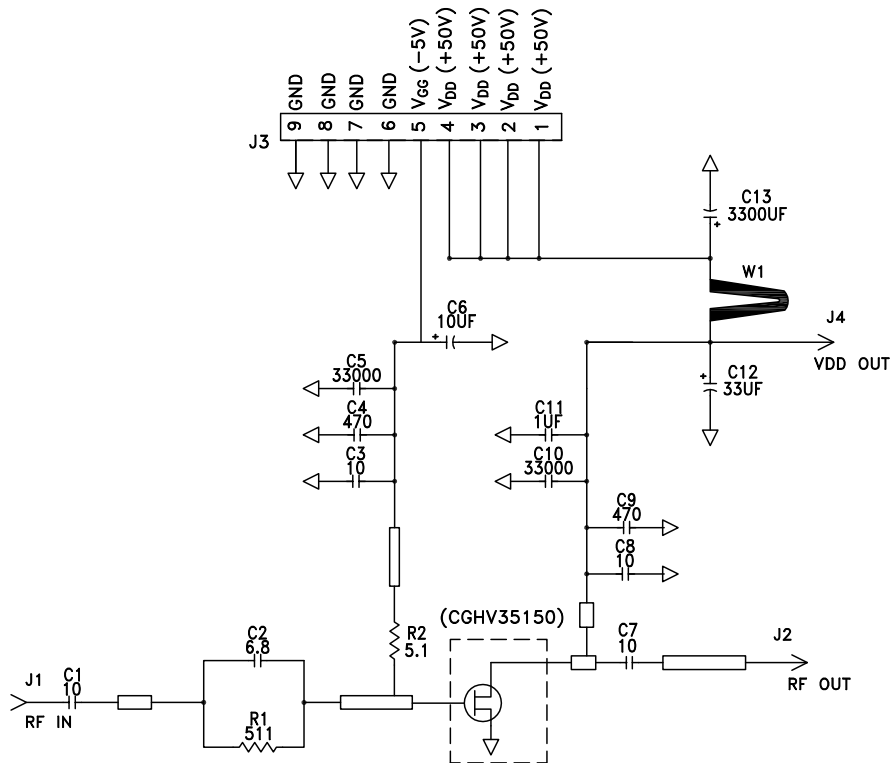

Product Dimensions CGHV35150F (Package Type – 440193)

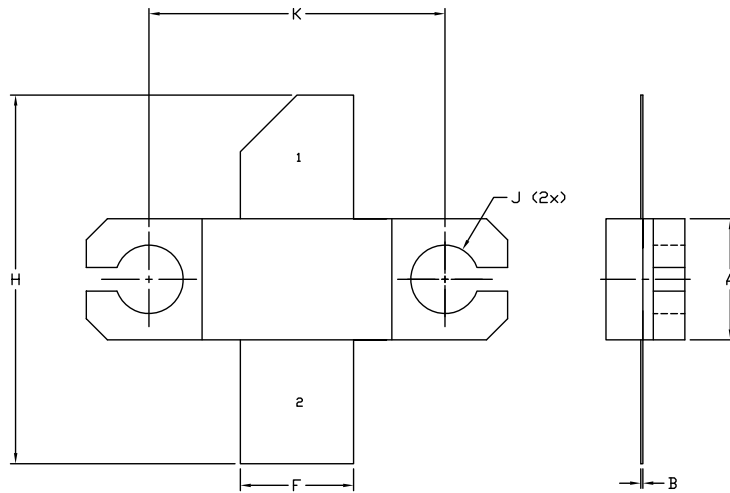

- NOTES:
1. DIMENSIONING AND TOLERANCING PER ANSI Y14.5M, 1982.
 2. CONTROLLING DIMENSION: INCH.
 3. ADHESIVE FROM LID MAY EXTEND A MAXIMUM OF 0.020" BEYOND EDGE OF LID.
 4. LID MAY BE MISALIGNED TO THE BODY OF THE PACKAGE BY A MAXIMUM OF 0.008" IN ANY DIRECTION.
 5. ALL PLATED SURFACES ARE NI/AU

DIM	INCHES		MILLIMETERS	
	MIN	MAX	MIN	MAX
A	0.225	0.235	5.72	5.97
B	0.004	0.006	0.10	0.15
C	0.145	0.165	3.68	4.19
D	0.077	0.087	1.96	2.21
E	0.355	0.365	9.02	9.27
F	0.210	0.220	5.33	5.59
G	0.795	0.805	20.19	20.45
H	0.670	0.730	17.02	18.54
J	Ø .130		3.30	
k	0.562		14.28	

- PIN 1. GATE
PIN 2. DRAIN
PIN 3. SOURCE

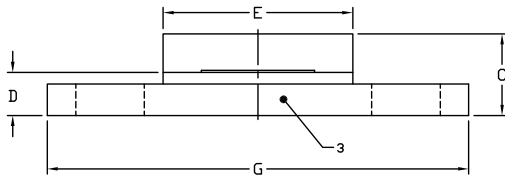

Product Dimensions CGHV35150P (Package Type – 440206)

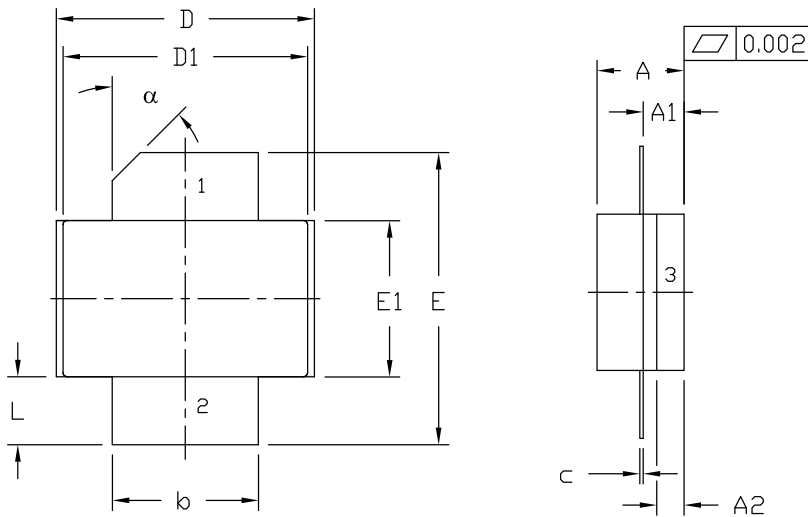

NOTES:

1. DIMENSIONING AND TOLERANCING PER ANSI Y14.5M - 1994.
2. CONTROLLING DIMENSION: INCH.
3. ADHESIVE FROM LID MAY EXTEND A MAXIMUM OF 0.020" BEYOND EDGE OF LID.
4. LID MAY BE MISALIGNED TO THE BODY OF PACKAGE BY A MAXIMUM OF 0.008" IN ANY DIRECTION.

DIM	INCHES		MILLIMETERS		NOTES
	MIN	MAX	MIN	MAX	
A	0.125	0.145	3.18	3.68	
A1	0.057	0.067	1.45	1.70	
A2	0.035	0.045	0.89	1.14	
b	0.210	0.220	5.33	5.59	2x
c	0.004	0.006	0.10	0.15	2x
D	0.375	0.385	9.53	9.78	
D1	0.355	0.365	9.02	9.27	
E	0.400	0.460	10.16	11.68	
E1	0.225	0.235	5.72	5.97	
L	0.085	0.115	2.16	2.92	2x
alpha	45° REF		45° REF		

- PIN 1. GATE
2. DRAIN
3. SOURCE

CGHV35150F/P



Parameter	Value	Units
Upper Frequency ¹	3.5	GHz
Power Output	150	W
Package	Flange	-

Table 1.

Note¹: Alpha characters used in frequency code indicate a value greater than 9.9 GHz. See Table 2 for value.

Character Code	Code Value
A	0
B	1
C	2
D	3
E	4
F	5
G	6
H	7
J	8
K	9
Examples:	1A = 10.0 GHz 2H = 27.0 GHz

Table 2.

Product Ordering Information

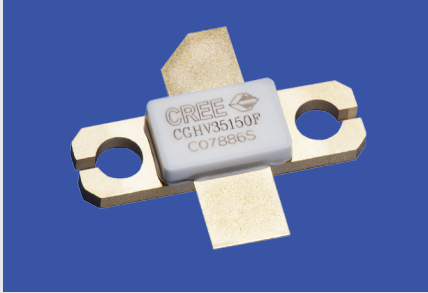
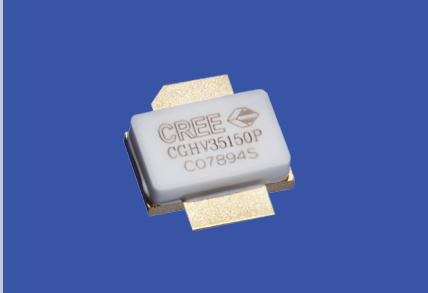
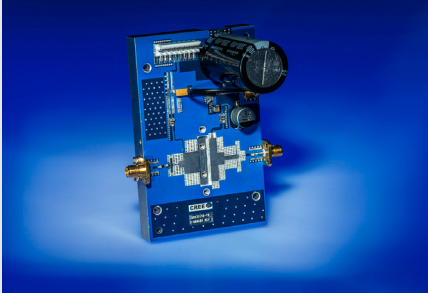
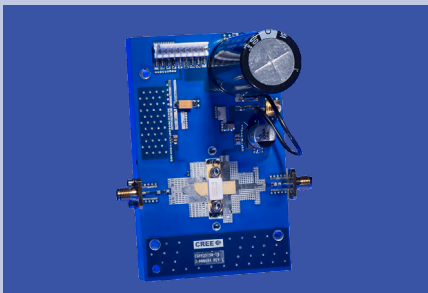
Order Number	Description	Unit of Measure	Image
CGHV35150F	GaN HEMT	Each	
CGHV35150P	GaN HEMT	Each	
CGHV35150-TB	Test board without GaN HEMT	Each	
CGHV35150F-AMP	Test board with GaN HEMT installed	Each	



Disclaimer

Specifications are subject to change without notice. Cree, Inc. believes the information contained within this data sheet to be accurate and reliable. However, no responsibility is assumed by Cree for any infringement of patents or other rights of third parties which may result from its use. No license is granted by implication or otherwise under any patent or patent rights of Cree. Cree makes no warranty, representation or guarantee regarding the suitability of its products for any particular purpose. "Typical" parameters are the average values expected by Cree in large quantities and are provided for information purposes only. These values can and do vary in different applications and actual performance can vary over time. All operating parameters should be validated by customer's technical experts for each application. Cree products are not designed, intended or authorized for use as components in applications intended for surgical implant into the body or to support or sustain life, in applications in which the failure of the Cree product could result in personal injury or death or in applications for planning, construction, maintenance or direct operation of a nuclear facility.

For more information, please contact:

Cree, Inc.
4600 Silicon Drive
Durham, North Carolina, USA 27703
www.cree.com/rf

Sarah Miller
Marketing
Cree, RF Components
1.919.407.5302

Ryan Baker
Marketing & Sales
Cree, RF Components
1.919.407.7816

Tom Dekker
Sales Director
Cree, RF Components
1.919.407.5639